

Kleiderschrank 6 turing

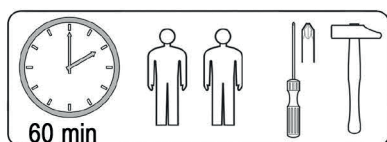

3576x2160x600

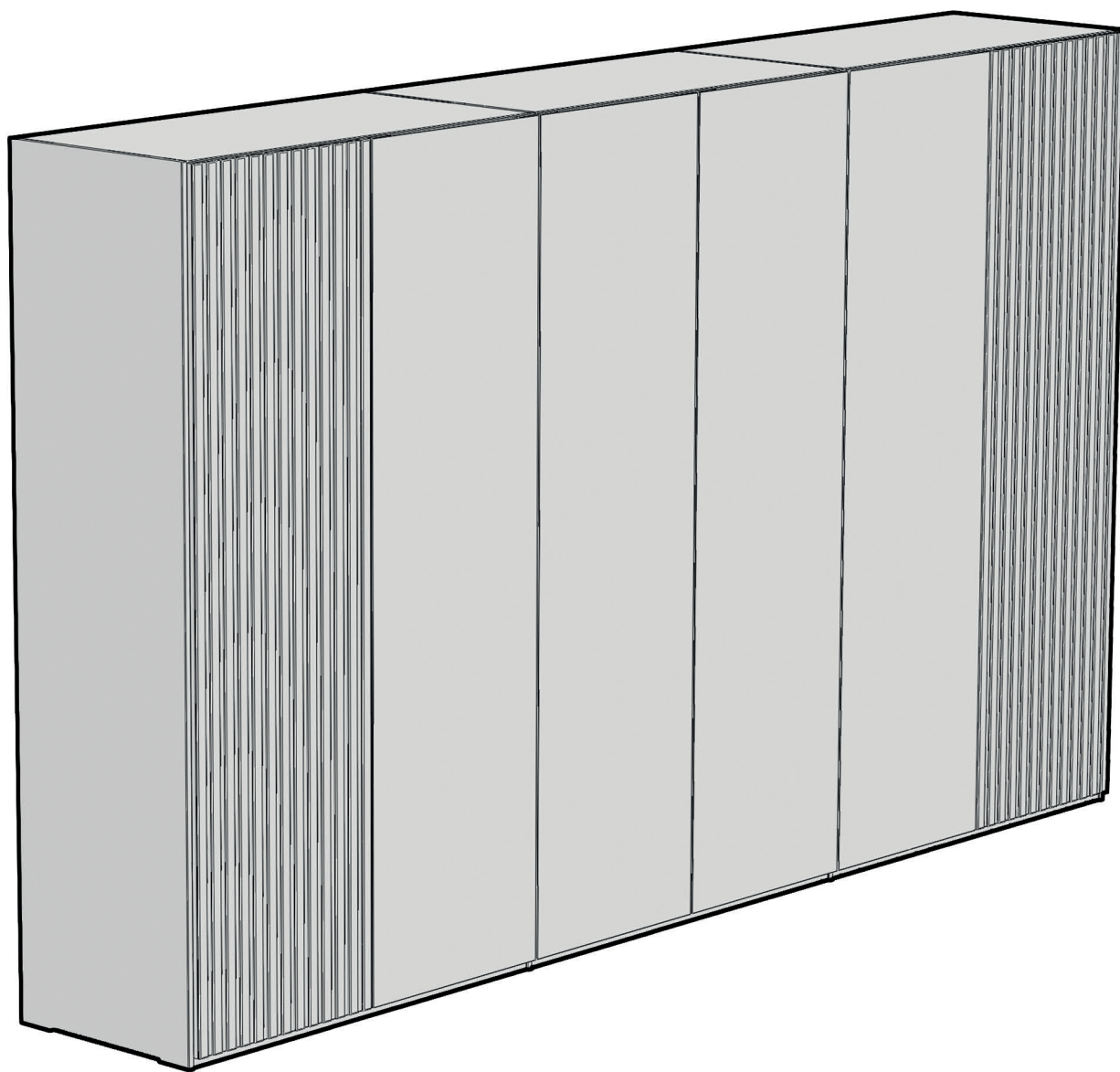

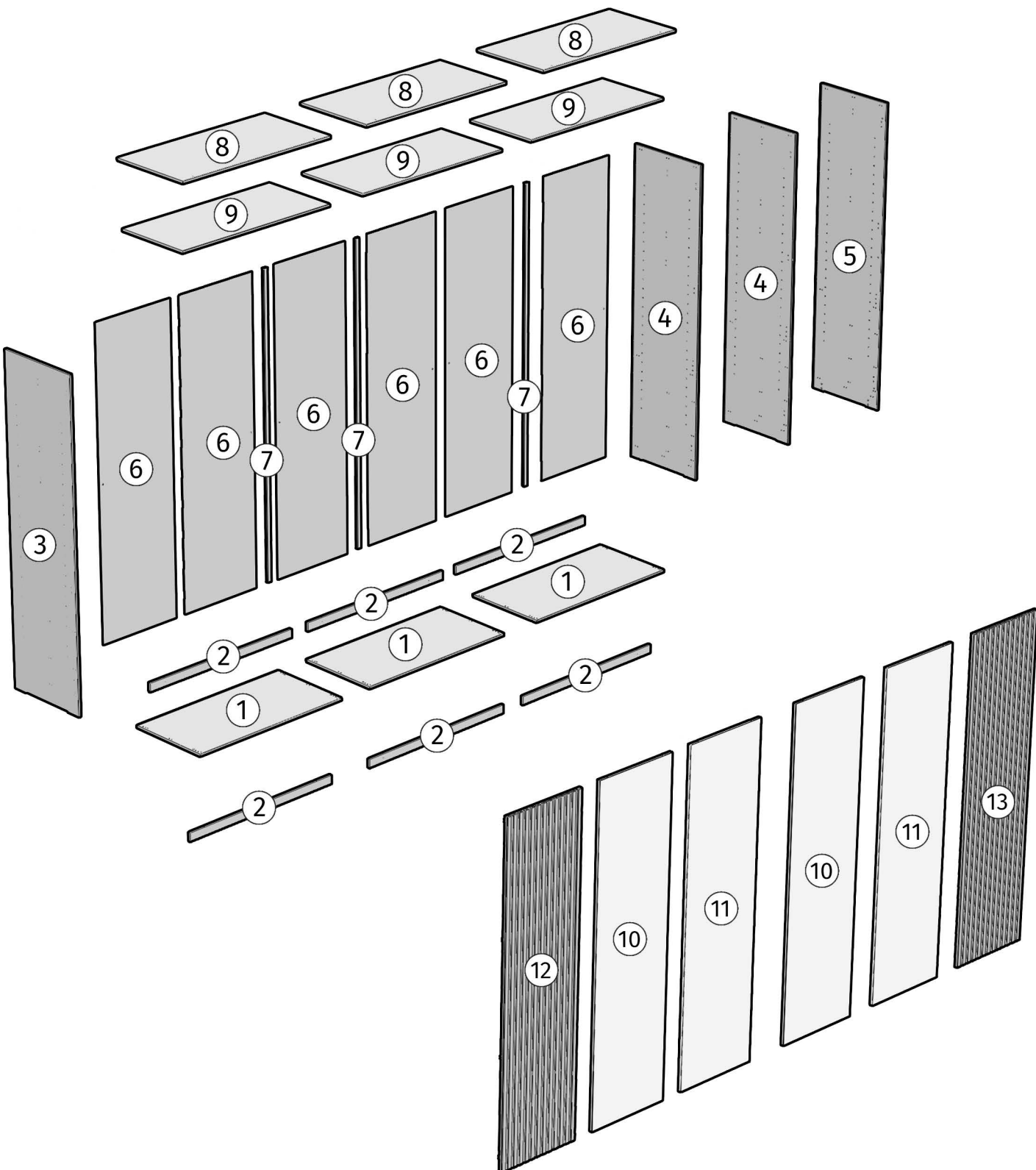
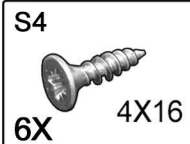
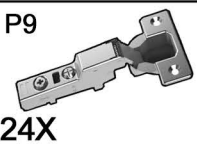
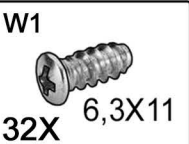
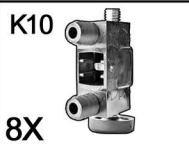
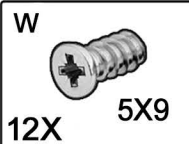
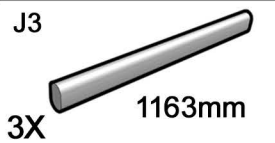
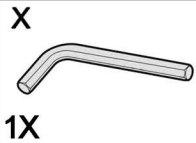
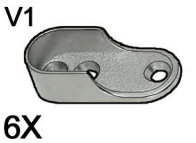
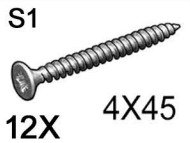
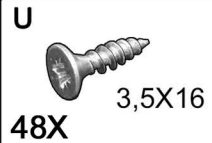
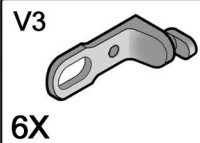
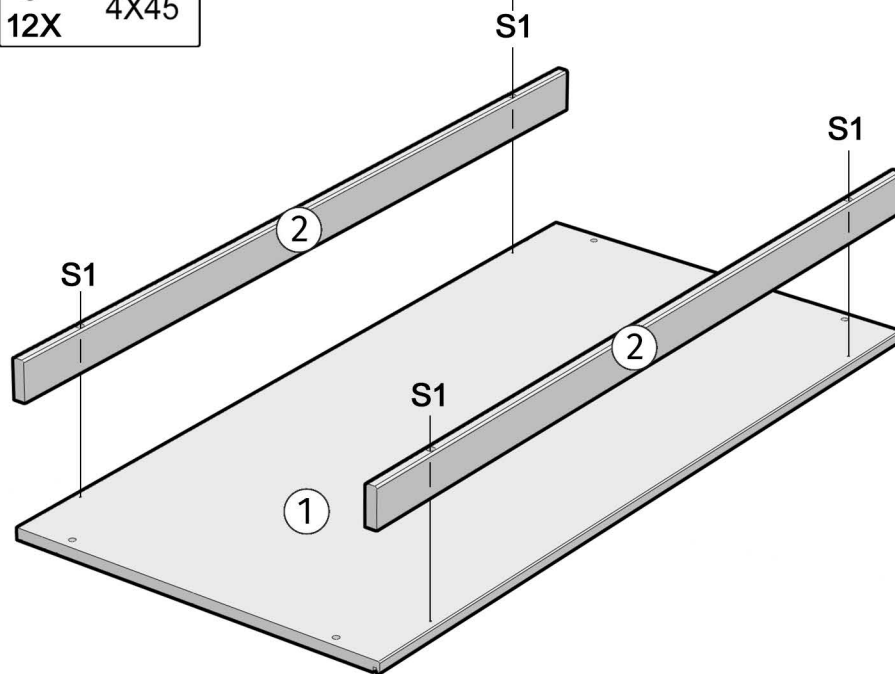
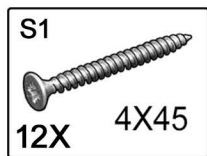

3X

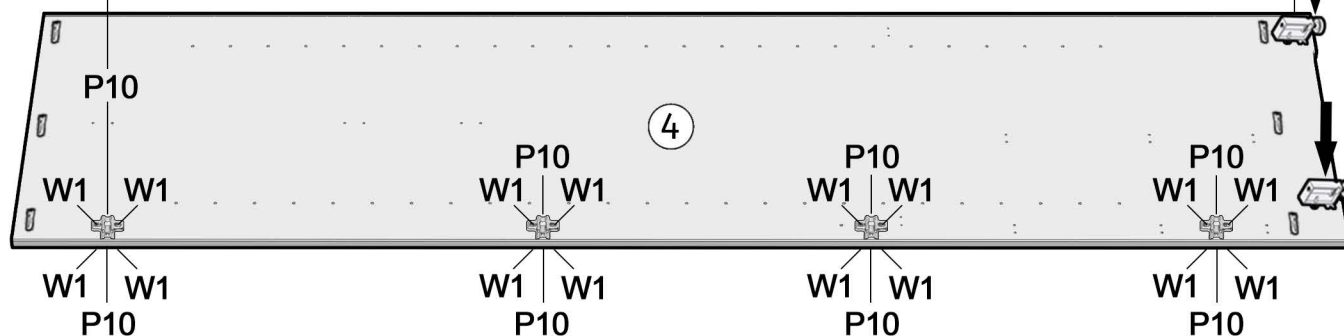
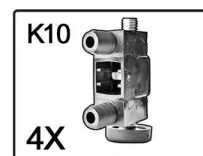
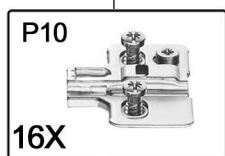
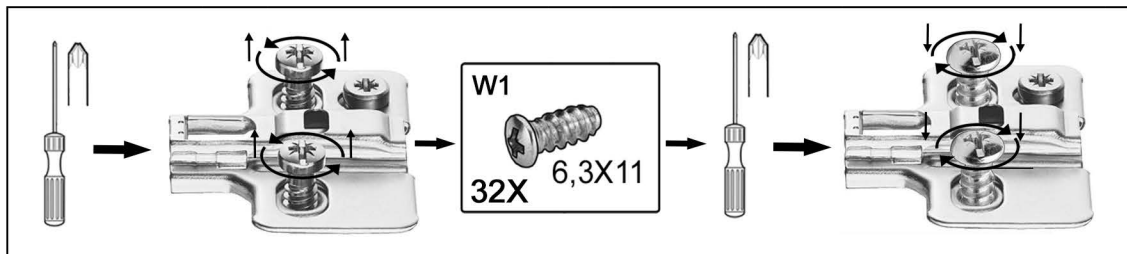

2X

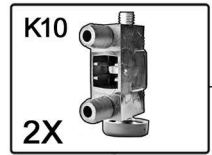
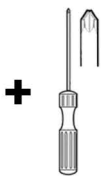
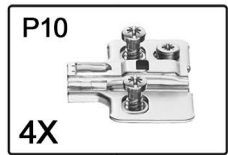

K10

P10

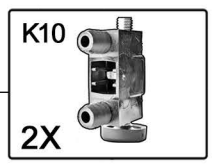
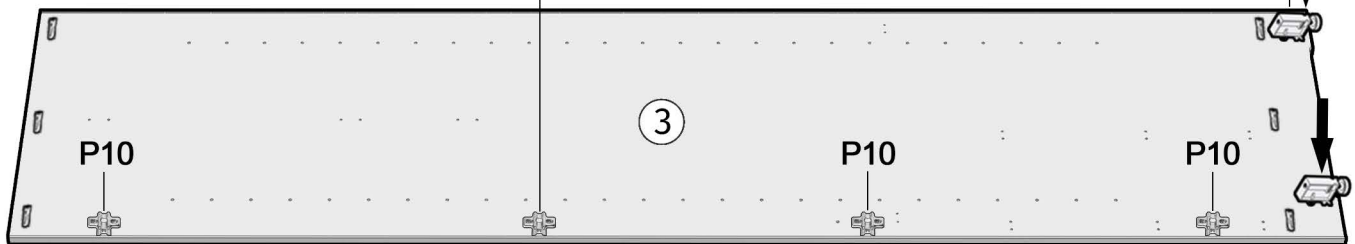

K10

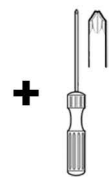

P10

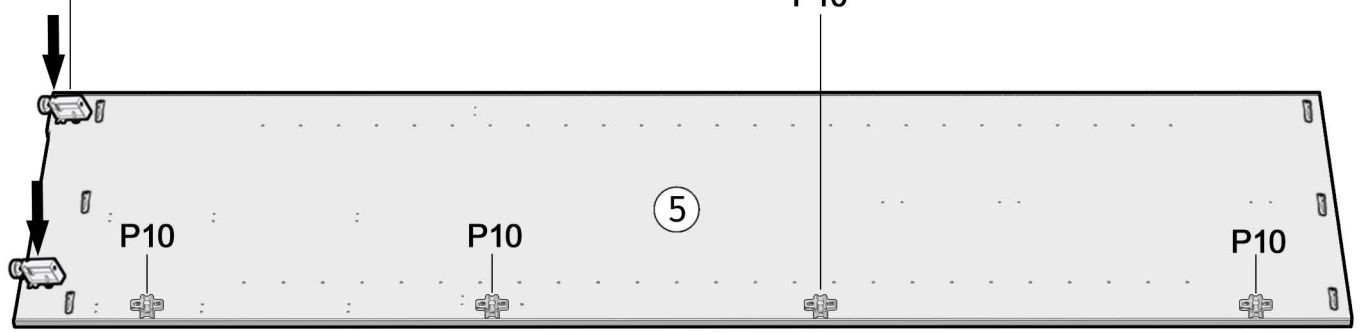

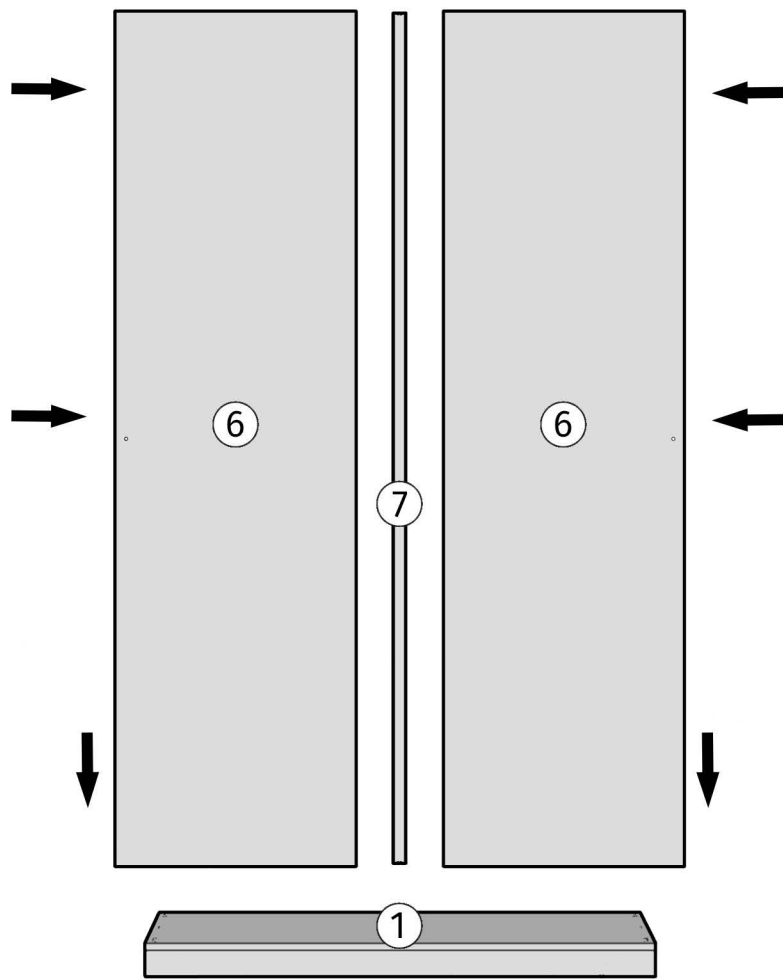

3X

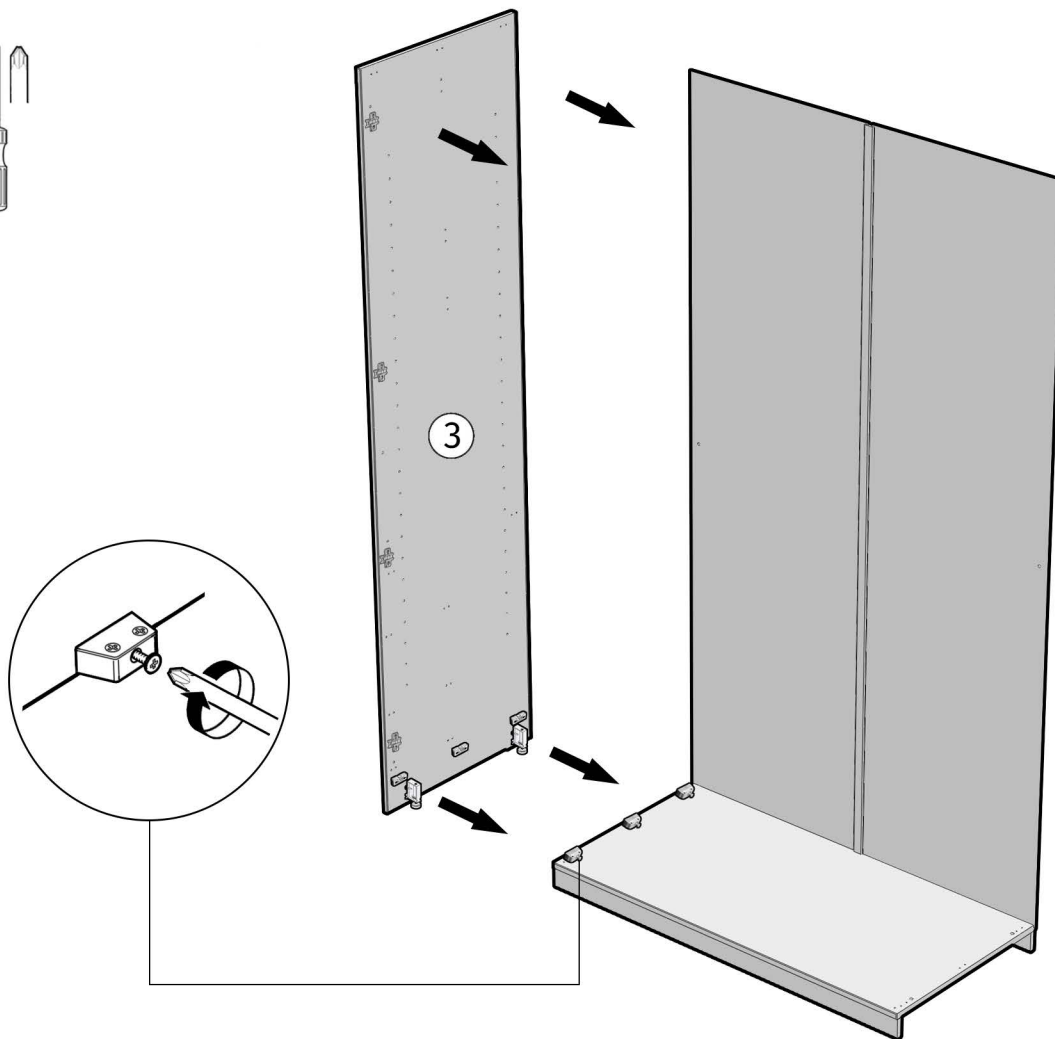

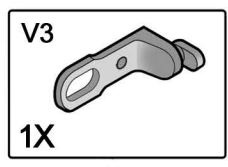
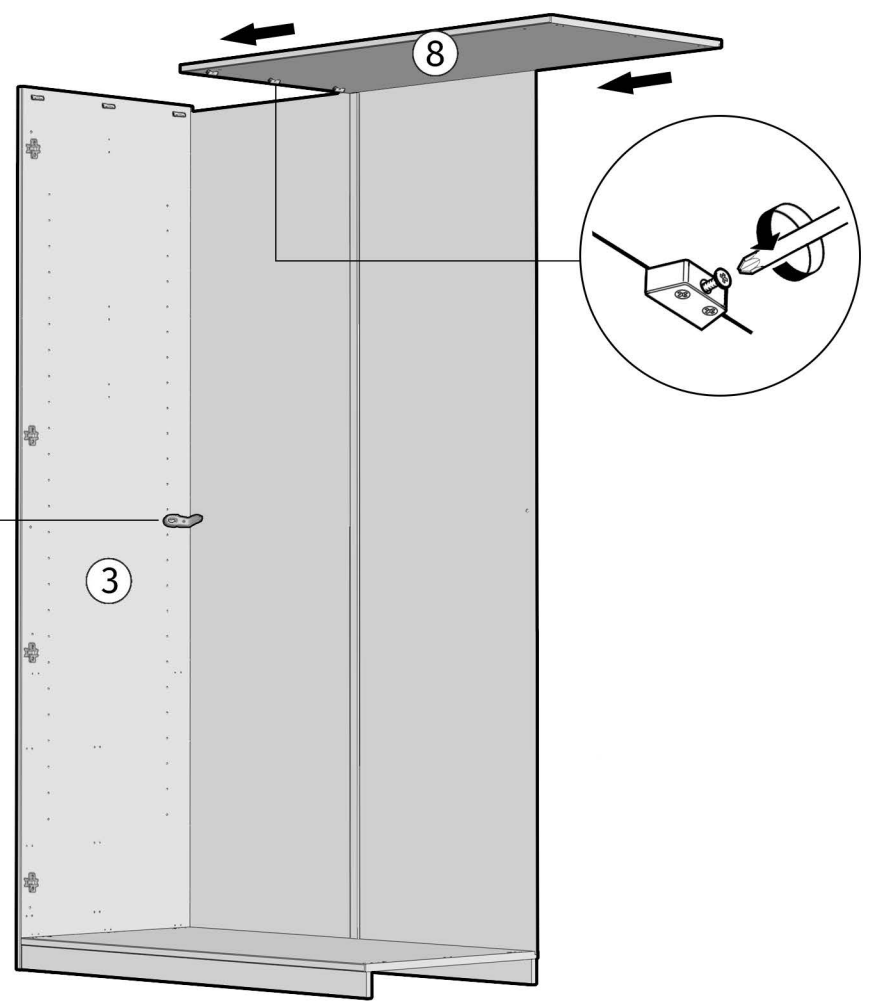
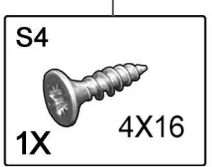
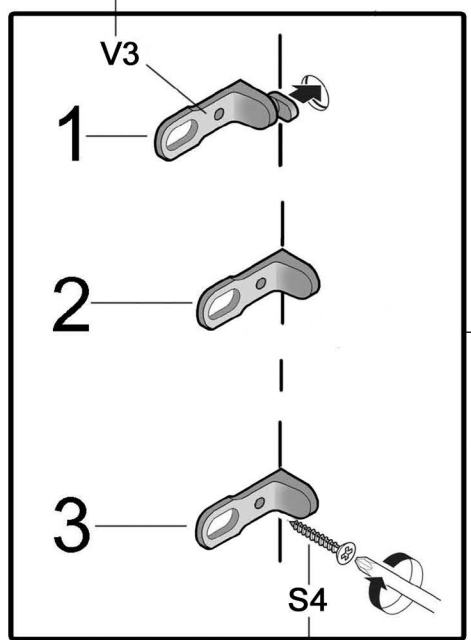
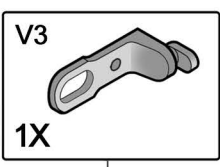
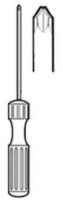

+

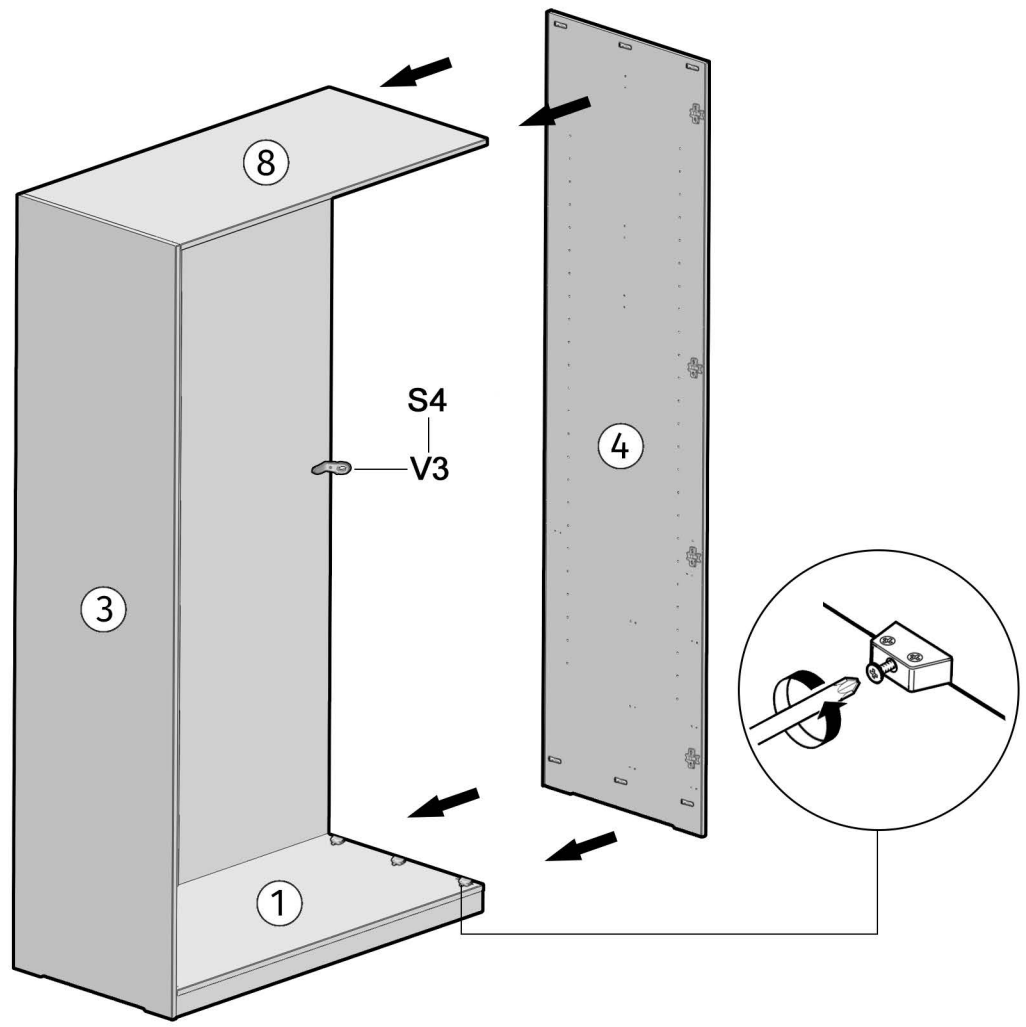
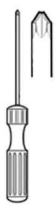
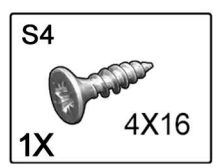

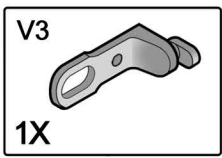

+

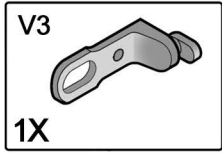
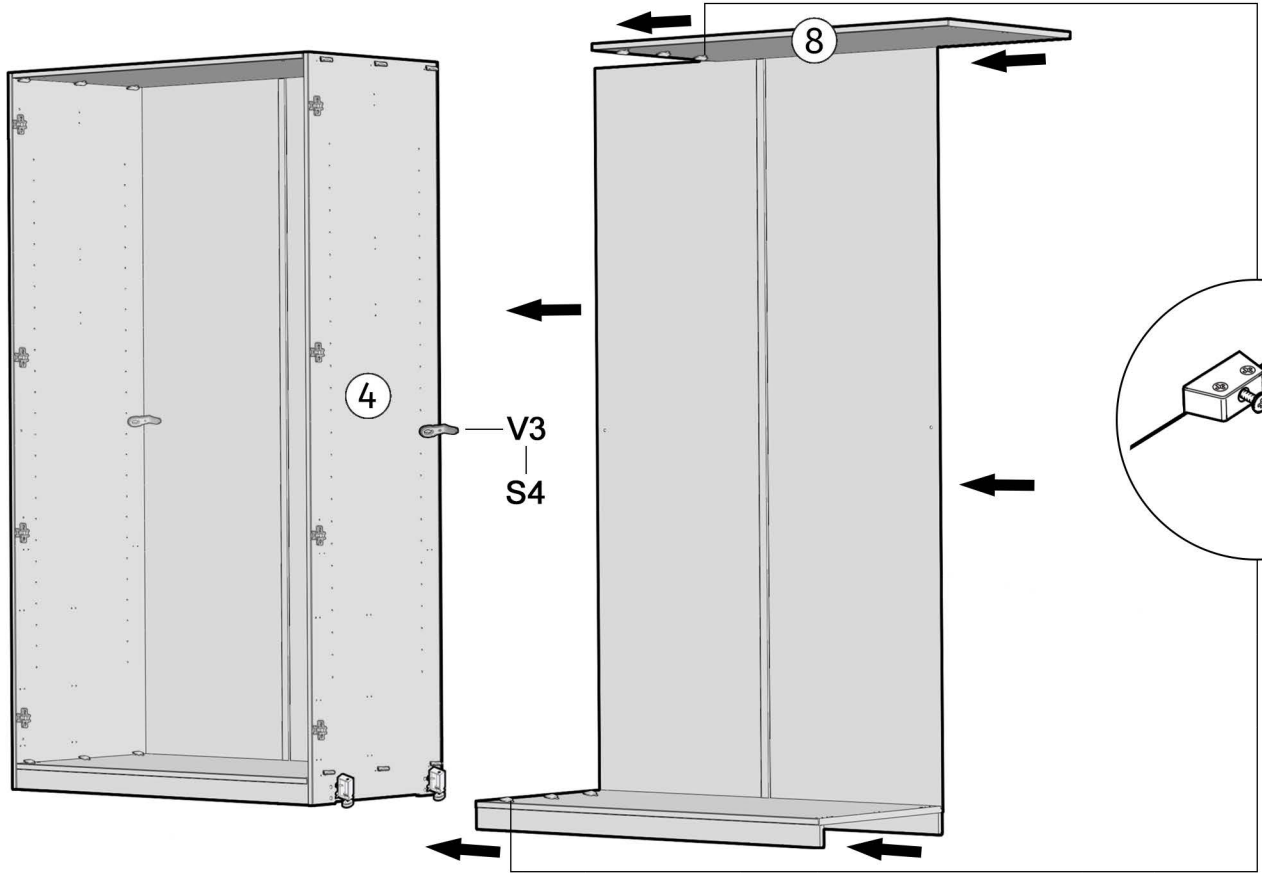
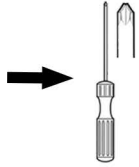
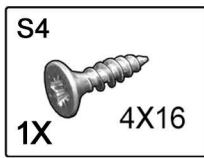

+

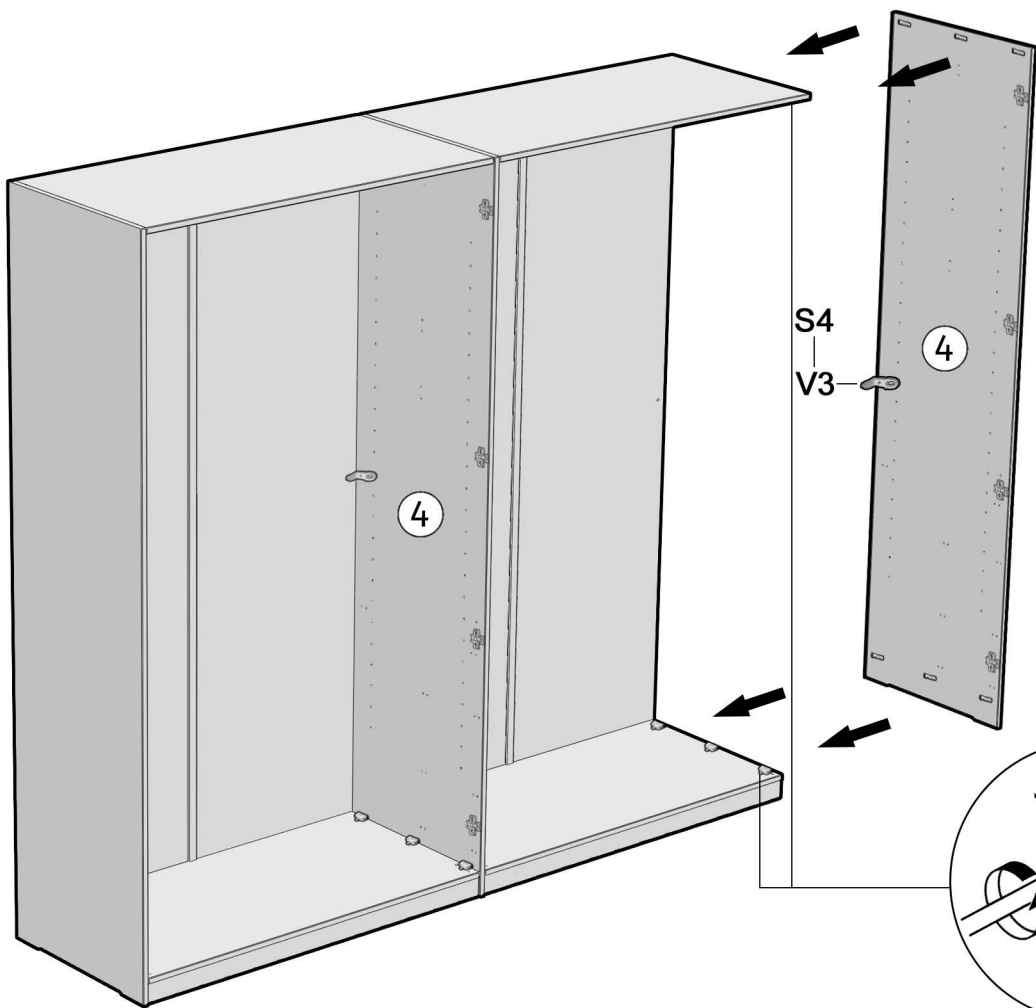
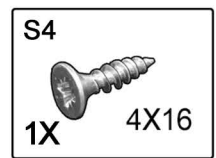

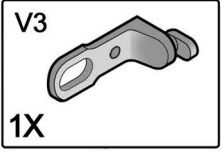

+

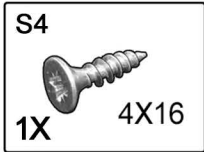

→

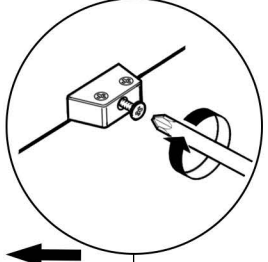
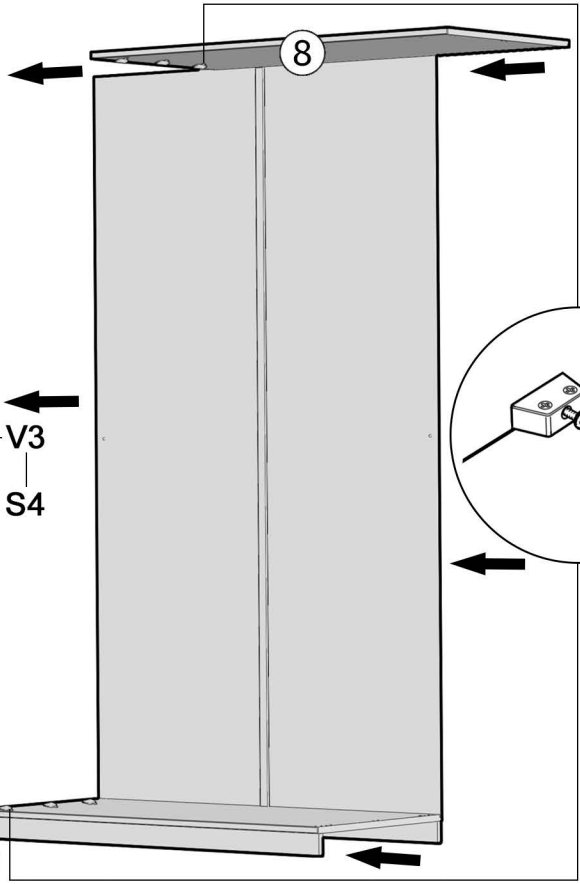
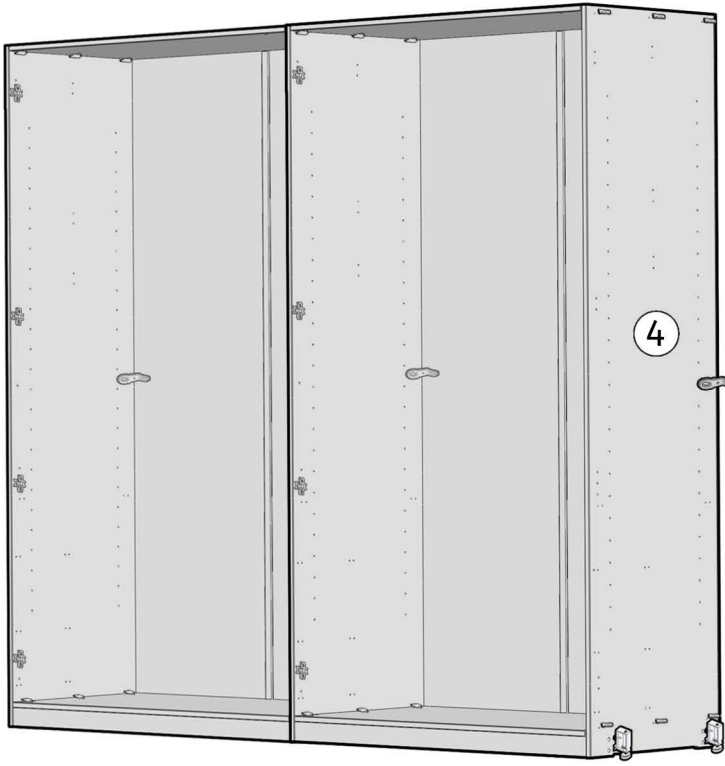
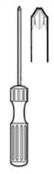

V3
S4

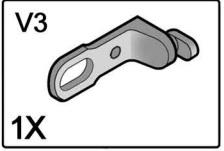

+

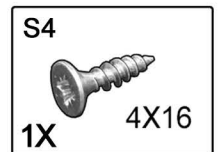

↓

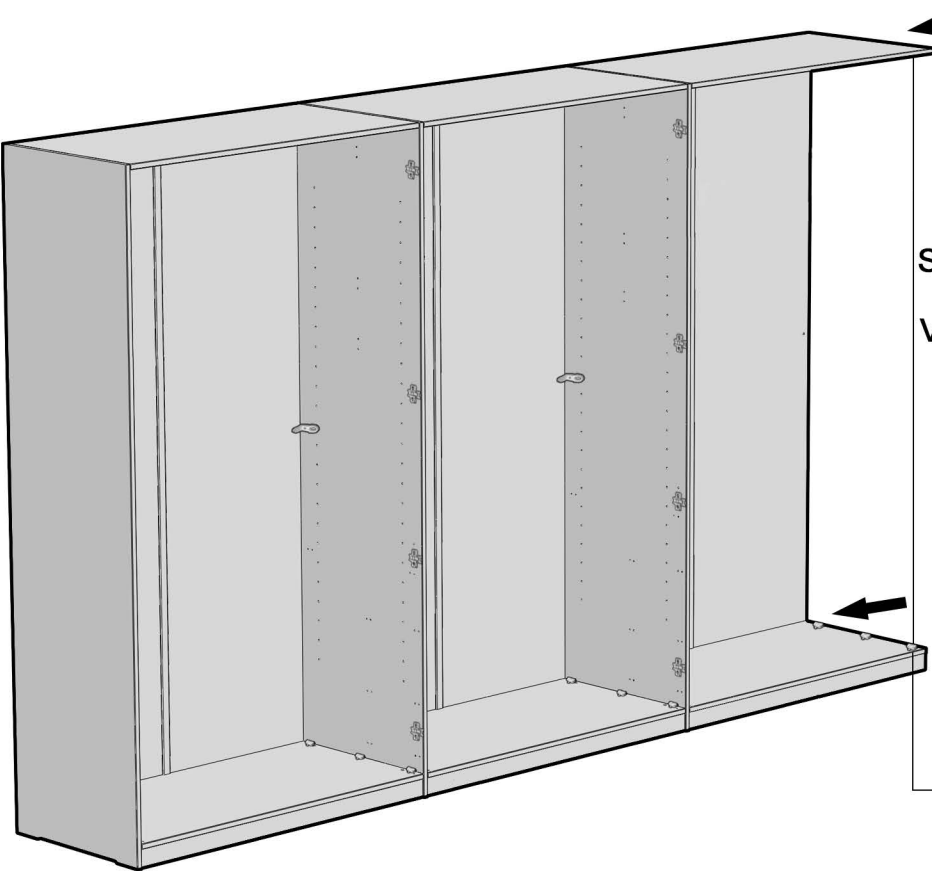

S4
V3

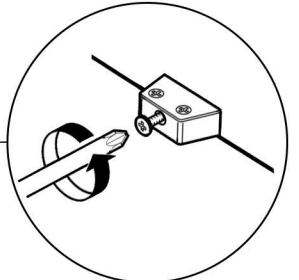

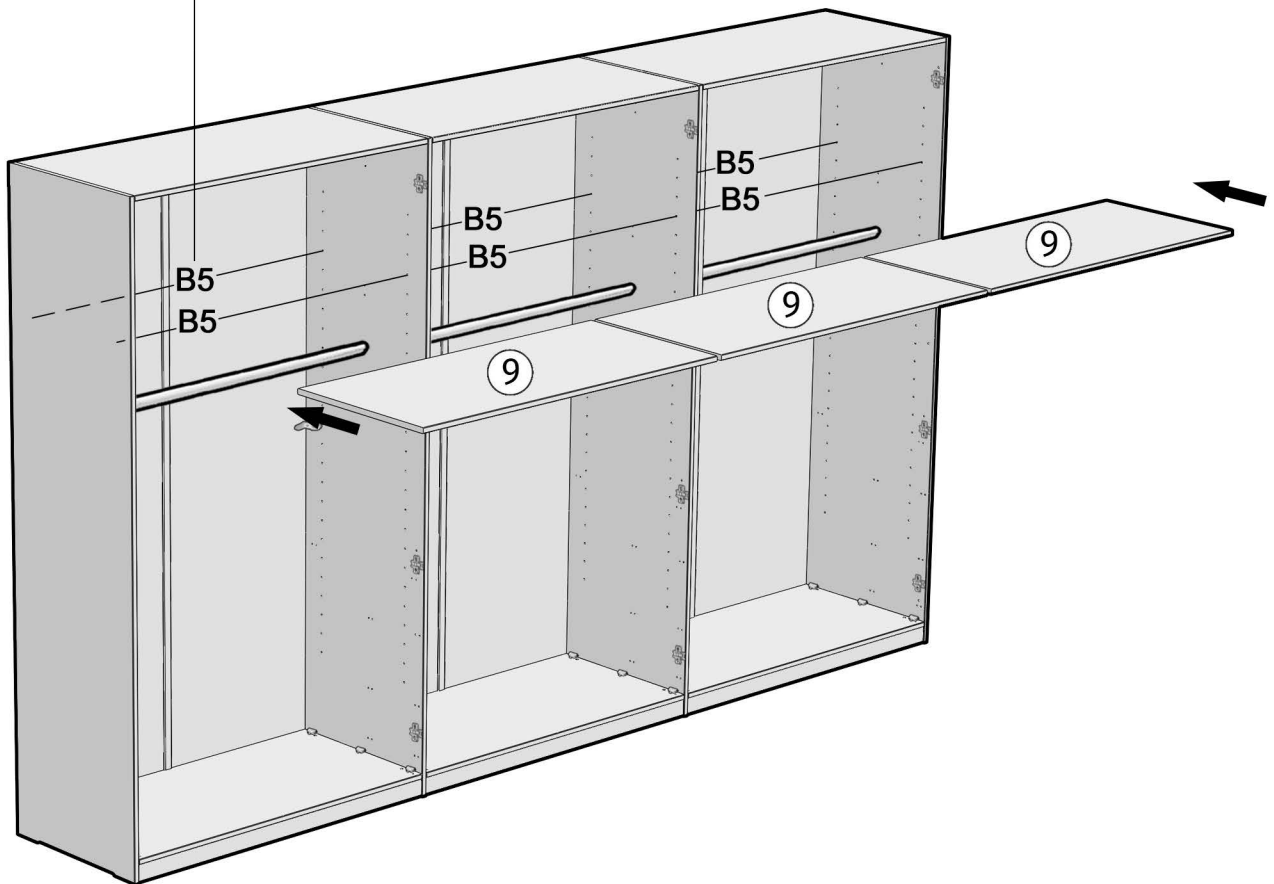
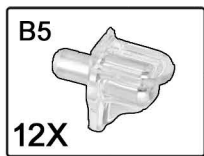
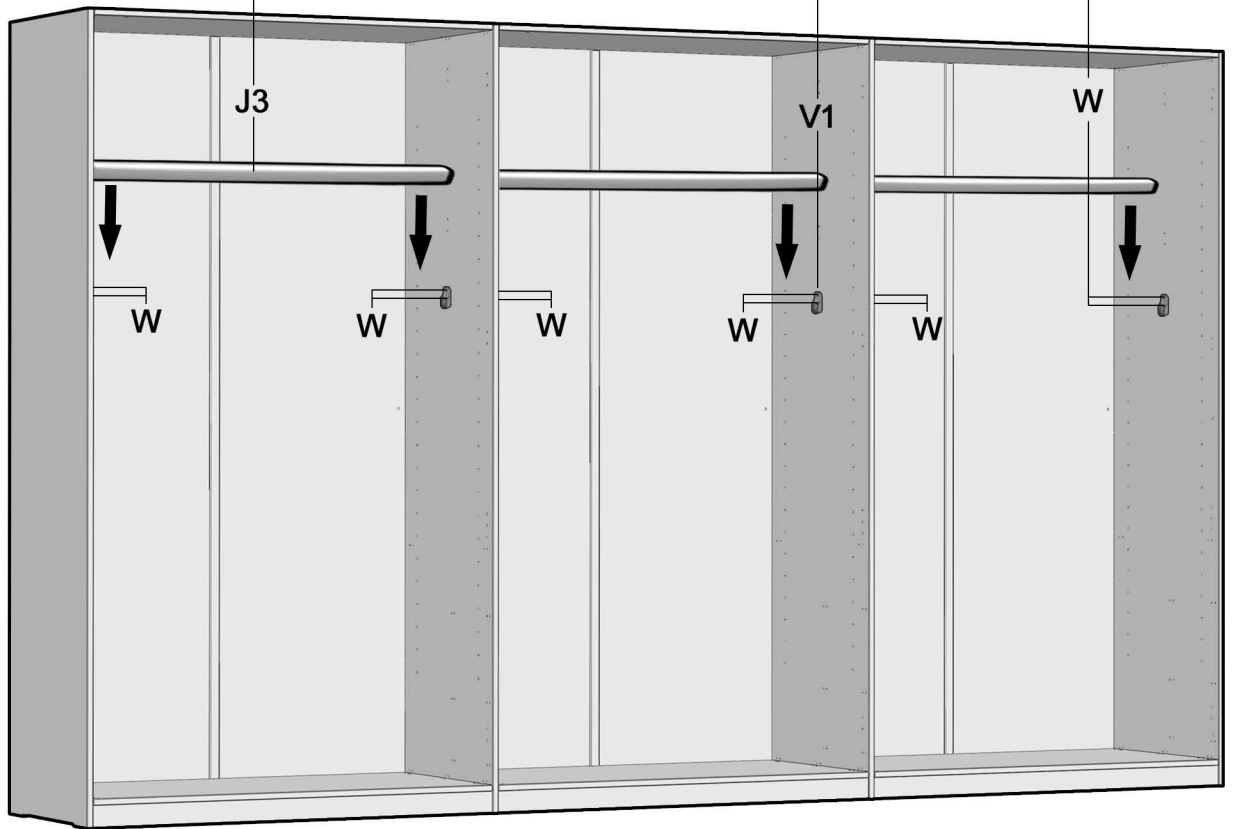
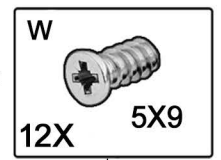
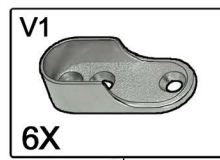
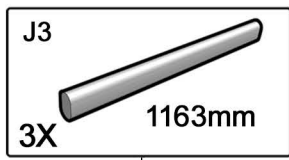

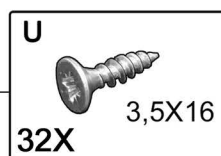
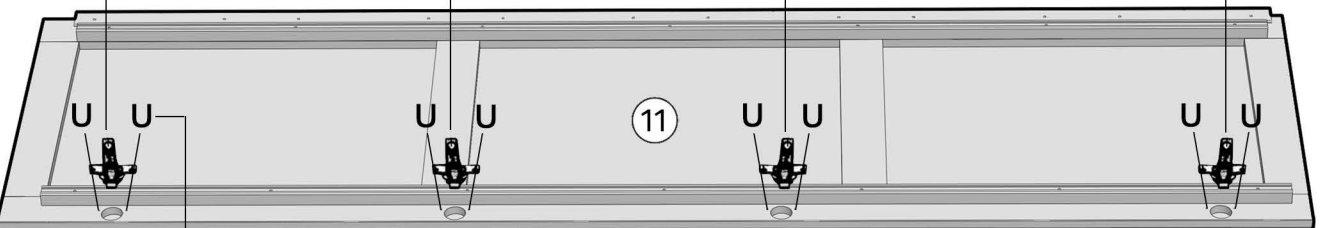
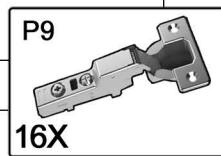
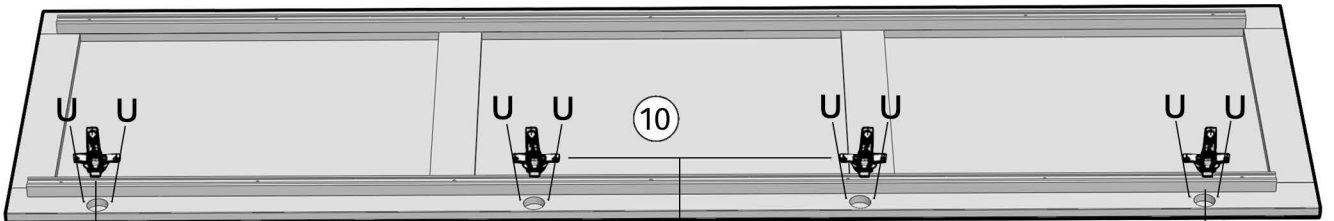
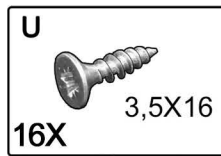
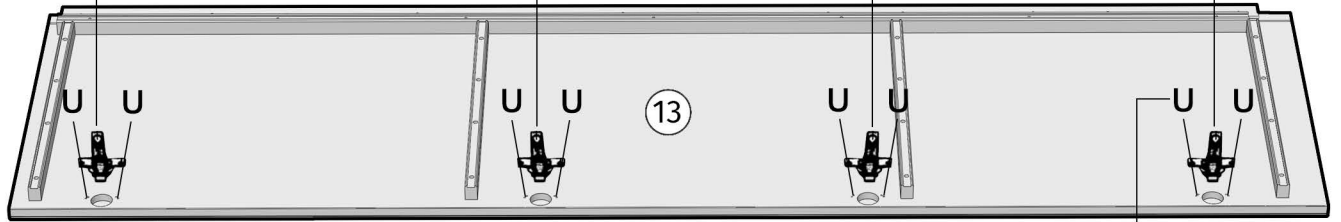
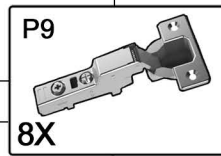
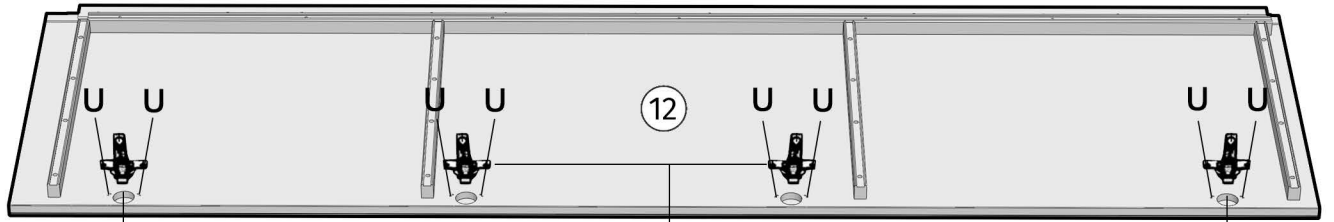

2X

